

- > Valve slices 2 x 3/2, 5/2 and 5/3 with integral push-in fittings Ø 6, 8 and 10 mm
- > Multipole or individually wired for installation flexibility
- > Compact and lightweight, integral push in fittings
- > High flow from 15 mm valve width
- > For Ex applications conforming to Zone 2 category ATEX 3G (gases): II3G Ex nA IIc T5 Gc  
Zone 22 category ATEX 3D (dusts): II3D Ex tc IIIc T90°C Dc -5°C < Ta > +50°C
- > Quick disconnect base (Pneumapole)
- > To configure and order a Valve Island visit: [vi.norgren.com](http://vi.norgren.com)



### Technical features

#### Medium:

Compressed air, filtered, lubricated and non-lubricated

#### Operation:

Spool valve indirectly actuated

#### Port sizes:

Ports 1, 3 & 5: Ø 10 & 12 mm

Ports 2 & 4: Ø 6, 8 & 10 mm

Ports 12/14 & 82/84: Ø 6 mm push-in fittings

Imperial versions also available

#### Flow:

Function	Cv	l/min
5/2	1,01	1000
2x3/2	0,97	965
5/3	0,91	900

#### Degree of protection:

Individually wired: IP40

Multipole: IP65

#### Ambient/Media temperature:

-5 ... +50°C (+23 ... +122 °F)

Air supply must be dry enough

to avoid ice formation at

temperatures below 2°C (+35°F).

#### Materials:

Body, end plates: engineered

PPA co-polymer

Spool: aluminium

Seals: NBR

### Electrical details

<b>Voltage:</b>	<b>24 V d.c. 1,2 W*</b>
Surge suppression:	Flywheel diode
Indication:	Yellow LED

\* 12 V d.c. also available.

Please consult our Technical Service.

### Solenoids

<b>Voltage tolerance:</b>	<b>± 10%</b>
Rating:	100% ED

Technical data

2 x 3/2 Double solenoid actuated valves

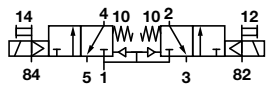
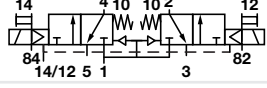
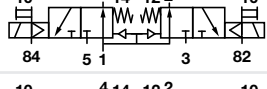
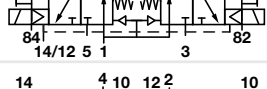
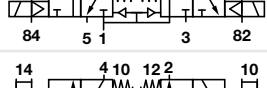
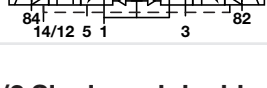
Symbol	Function	Actuation	Pilot supply	Manual override	Operating pressure (bar)	Pilot pressure (bar)	Weight (kg)	Model
	2 x 3/2 NC	Solenoid/spring	Internal	Push and turn to lock	3 ... 8	–	0,10	VM15*A11AB213B
	2 x 3/2 NC	Solenoid/spring	Internal	Push only	3 ... 8	–	0,10	VM15*A11AB313B
	2 x 3/2 NC	Solenoid/spring	External	Push and turn to lock	-0,9 ... 8	3 ... 8	0,10	VM15*A22AB213B
	2 x 3/2 NC	Solenoid/spring	External	Push only	-0,9 ... 8	3 ... 8	0,10	VM15*A22AB313B
	2 x 3/2 NO	Solenoid/spring	Internal	Push and turn to lock	3 ... 8	–	0,10	VM15*B11AB213B
	2 x 3/2 NO	Solenoid/spring	Internal	Push only	3 ... 8	–	0,10	VM15*B11AB313B
	2 x 3/2 NO	Solenoid/spring	External	Push and turn to lock	-0,9 ... 8	3 ... 8	0,10	VM15*B22AB213B
	2 x 3/2 NO	Solenoid/spring	External	Push only	-0,9 ... 8	3 ... 8	0,10	VM15*B22AB313B
	2 x 3/2 NO/NC	Solenoid/spring	Internal	Push and turn to lock	3 ... 8	–	0,10	VM15*C11AB213B
	2 x 3/2 NO/NC	Solenoid/spring	Internal	Push only	3 ... 8	–	0,10	VM15*C11AB313B
	2 x 3/2 NO/NC	Solenoid/spring	External	Push and turn to lock	-0,9 ... 8	3 ... 8	0,10	VM15*C22AB213B
	2 x 3/2 NO/NC	Solenoid/spring	External	Push only	-0,9 ... 8	3 ... 8	0,10	VM15*C22AB313B

5/2 Single and double solenoid actuated valves

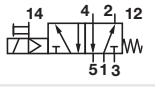
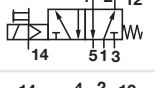
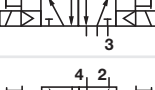
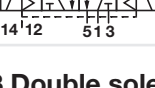
Symbol	Function	Actuation	Pilot supply	Manual override	Operating pressure (bar)	Pilot pressure (bar)	Weight (kg)	Model
	5/2	Solenoid/spring	Internal	Push and turn to lock	3 ... 8	–	0,09	VM15*517AB213B
	5/2	Solenoid/spring	Internal	Push only	3 ... 8	–	0,09	VM15*517AB313B
	5/2	Solenoid/spring	External	Push and turn to lock	-0,9 ... 8	3 ... 8	0,09	VM15*527AB213B
	5/2	Solenoid/spring	External	Push only	-0,9 ... 8	3 ... 8	0,09	VM15*527AB313B
	5/2	Solenoid/solenoid	Internal	Push and turn to lock	3 ... 8	–	0,10	VM15*511AB213B
	5/2	Solenoid/solenoid	Internal	Push only	3 ... 8	–	0,10	VM15*511AB313B
	5/2	Solenoid/solenoid	External	Push and turn to lock	-0,9 ... 8	2 ... 8	0,10	VM15*522AB213B
	5/2	Solenoid/solenoid	External	Push only	-0,9 ... 8	2 ... 8	0,10	VM15*522AB313B

5/3 Double solenoid actuated valves

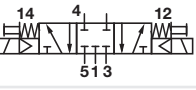
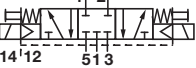
Symbol	Function	Actuation	Pilot supply	Manual override	Operating pressure (bar)	Pilot pressure (bar)	Weight (kg)	Model
	5/3 APB	Solenoid/solenoid	Internal	Push and turn to lock	3 ... 8	–	0,10	VM15*611AB213B
	5/3 APB	Solenoid/solenoid	Internal	Push only	3 ... 8	–	0,10	VM15*611AB313B
	5/3 APB	Solenoid/solenoid	External	Push and turn to lock	0,9 ... 8	3 ... 8	0,10	VM15*622AB213B
	5/3 APB	Solenoid/solenoid	External	Push only	0,9 ... 8	3 ... 8	0,10	VM15*622AB313B

\* For selection of port sizes please see page 3

Note: For 5/3 COE please use 2 x 3/2 NC. For 5/3 COP please use 2 x 3/2 NO

APB = All Ports Blocked COE = Centre Open Exhaust COP = Centre Open Pressure

**Option selector**
**VM15\*\*\*\*\*AB\*13B**



Tube size	Substitute
6 mm PIF	<b>6</b>
8 mm PIF	<b>8</b>
10 mm PIF	<b>Y</b>
No PIF (for use with Pneumapole) *1)	<b>7</b>
Valve function	Substitute
5/2	<b>5</b>
5/3 APB	<b>6</b>
2 x 3/2 NC and 5/3 COE	<b>A</b>
2 x 3/2 NO and 5/3 COP	<b>B</b>
2 x 3/2 NC and NO	<b>C</b>

Manual override	Substitute
Turn to lock	<b>2</b>
Push only	<b>3</b>
Actuation/pilot supply	Substitute
Solenoid/solenoid internal pilot	<b>11</b>
Solenoid/spring internal pilot *2)	<b>17</b>
Solenoid/solenoid external pilot	<b>22</b>
Solenoid/spring external pilot *2)	<b>27</b>



**Note:**



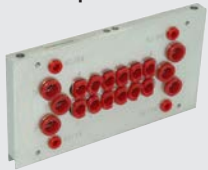

- For 5/3 COE and COP use
- 2 x 3/2 APB = All Ports Blocked
- COE = Centre Open Exhaust
- COP = Centre Open Pressure
- \*1) Requires Pneumapole sub-base
- \*2) Can only be used with 5/2 valve

**Accessories**

Valve blanking station	Port blanking station	Intermediate supply and exhaust manifold (ISEM)	Pneumapole sub-base
			
Page 6	Page 6	Page 5	Page 10 & 11
VM156517AQ0300	VM156517AQ0301 (Port 1 blanked)	VM156517AQ0304 (Feed right)	
	VM156517AQ0302 (Ports 3 & 5 blanked)	VM156517AQ0305 (Feed left)	
	VM156517AQ0303 (Ports 1, 3 & 5 blanked)	VM156517AQ0306 (Feed right and left)	

DIN Rail fixing kit	DIN rail	Label cover kit	Labels
			
V12022-K30	V10009-C00 (1 m)	V12016-K30 (4 Station)	V12033-L01 (write and seal label)
		V12016-K31 (6 Station)	V12034-L01 (paper label)
		V12016-K32 (8 Station)	
		V12016-K33 (10 Station)	
		V12016-K34 (12 Station)	
		V12016-K35 (16 Station)	

Pressure switch for pilot ports 12 and 14	Silencer	Plug
		
Page 11	Page 11	Page 11
VM106517AQ0806 (6 mm)	T45P0006 (6 mm)	C00040600 (6 mm)
	T45P0008 (8 mm)	C00040800 (8 mm)
	T45P0010 (10 mm)	C00041000 (10 mm)
	T45P0012 (12 mm)	C00041200 (12 mm)

D Sub-connector 25 pin, IP65	D Sub-connector 44 pin, IP65	D Sub-connector 25 pin 90°, IP65	D Sub-connector 44 pin 90°, IP65	2 Pin connector IP40
				
Page 9	Page 9	Page 10	Page 10	
V11569-E01 (1 m)	V11570-E01 (1 m)	V12086-E01 (1 m)	V12088-E01 (1 m)	V11556-E03 (0,3 m)
V11569-E03 (3 m)	V11570-E03 (3 m)	V12086-E03 (3 m)	V12088-E03 (3 m)	V11556-E03 (0,3 m)
V11569-E05 (5 m)	V11570-E05 (5 m)	V12086-E05 (5 m)	V12088-E05 (5 m)	

**Valve slices 2 x 3/2, 5/2 & 5/3 with integral push-in fittings - Ø 6, 8 or 10 mm**
**Dimensions**

 Dimensions in mm  
 Projection/First angle

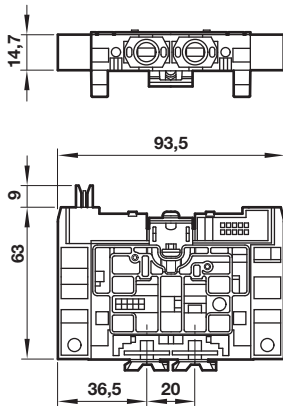
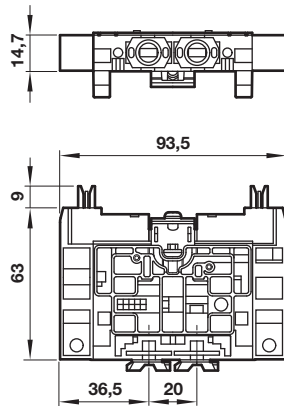
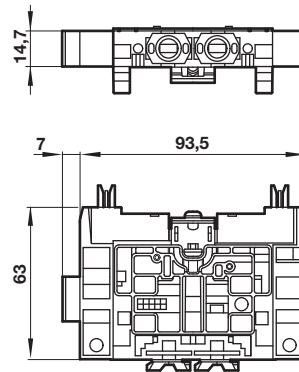
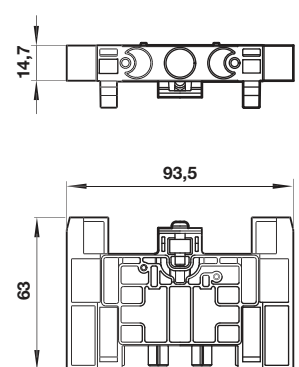
**Single solenoid**

**Double solenoid**

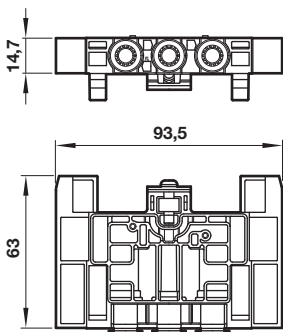
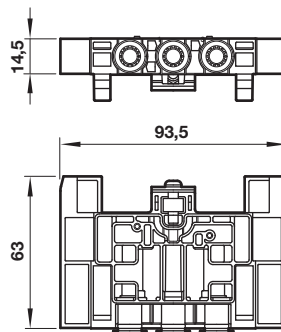
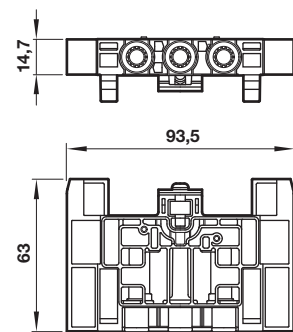
**5/3 APB, double solenoid**

**Blanking plates**

Valve blanking station	Port blanking station	Short code	Weight (kg)
VM156517AQ0300	VM156517AQ0301	Port 1 blanked	0,057
	VM156517AQ0302	Ports 3 & 5 blanked	0,057
	VM156517AQ0303	Ports 1, 3 & 5 blanked	0,057

**Intermediate supply and exhaust manifold (ISEM)**
**VM156517AQ0304**

**VM156517AQ0305**

**VM156517AQ0306**

ISEM	Push IN fittings	Weight (kg)	Model
Feed right	Ø 8 mm	0,064	VM156517AQ0304
Feed left	Ø 8 mm	0,064	VM156517AQ0305
Feed right & left	Ø 8 mm	0,064	VM156517AQ0306

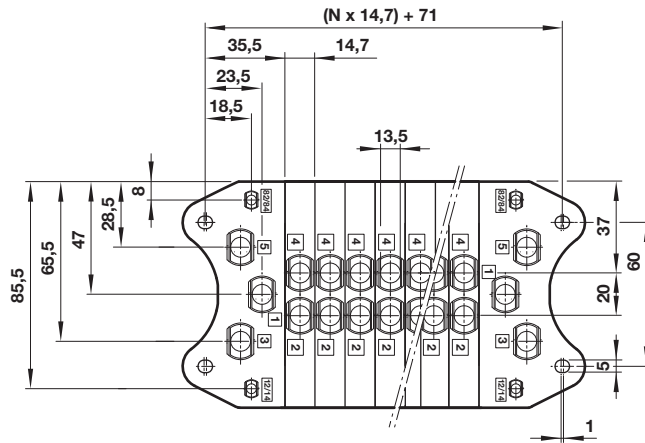
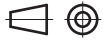
Port connections and mountings

Dimensions in mm  
Projection/First angle



N = number of stations



Description	Ports 1, 3 & 5 Tube outside Ø	Ports 12/14 & 82/84 Tube outside Ø	Ports 2 & 4 Tube outside Ø	Weight (kg)	Model
End plate kit - feed both ends	12	6	6, 8 or 10	0,30	VM156517AQ010Z
End plate kit - feed both ends	10	6	6, 8 or 10	0,30	VM156517AQ010Y
End plate kit - left blocked	12	6	6, 8 or 10	0,30	VM156517AQ011Z
End plate kit - left blocked	10	6	6, 8 or 10	0,30	VM156517AQ011Y
End plate kit - right blocked	12	6	6, 8 or 10	0,30	VM156517AQ012Z
End plate kit - right blocked	10	6	6, 8 or 10	0,30	VM156517AQ012Y
End plate kit - feed both ends - Pneumapole	no PIF	no PIF	no PIF	0,25	VM156517AQ0134
End plate kit - left blocked - Pneumapole	no PIF	no PIF	no PIF	0,25	VM156517AQ0136
End plate kit - right blocked - Pneumapole	no PIF	no PIF	no PIF	0,25	VM156517AQ0135

"Note: Ports 82/84 (solenoid pilot exhausts) should not be plugged. A filter or silencer can be fitted or the air can be piped away with tubing."

Modular assembly

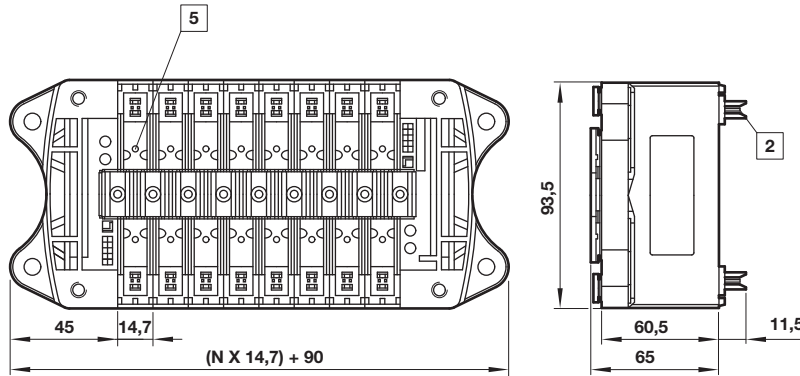
Individually wired IP40



 2 pin connector interface  
 Manual override  
N = number of stations

Individually wired	No. of stations	Max. no. of coils	Weight (kg)*
2 pin connector	2 ... 20	40	0,170

\* kg + valves weight

### Multipole IP65

Dimensions in mm  
Projection/First angle

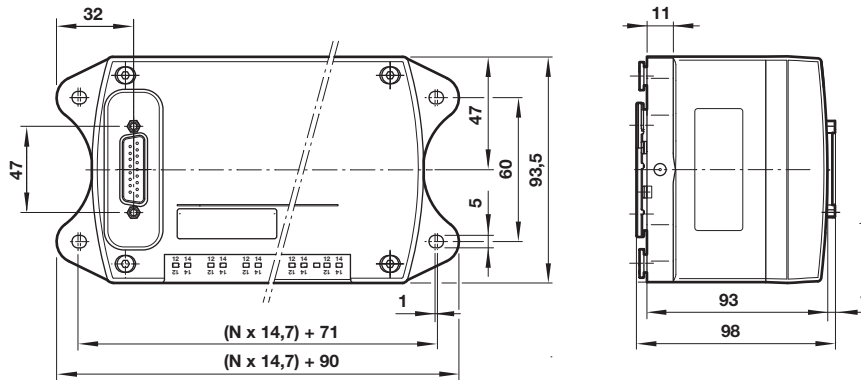

N = number of stations

Multipole	No. of stations	Model -ve common	Max. no. coils
25 Pin connector	4	VM156517AQ0404	8
25 Pin connector	6	VM156517AQ0406	12
25 Pin connector	8	VM156517AQ0408	16
25 Pin connector	10	VM156517AQ0410	20
25 Pin connector	12	VM156517AQ0412	24
44 Pin connector	16	VM156517AQ0516	32

### Pneumapole sub-base

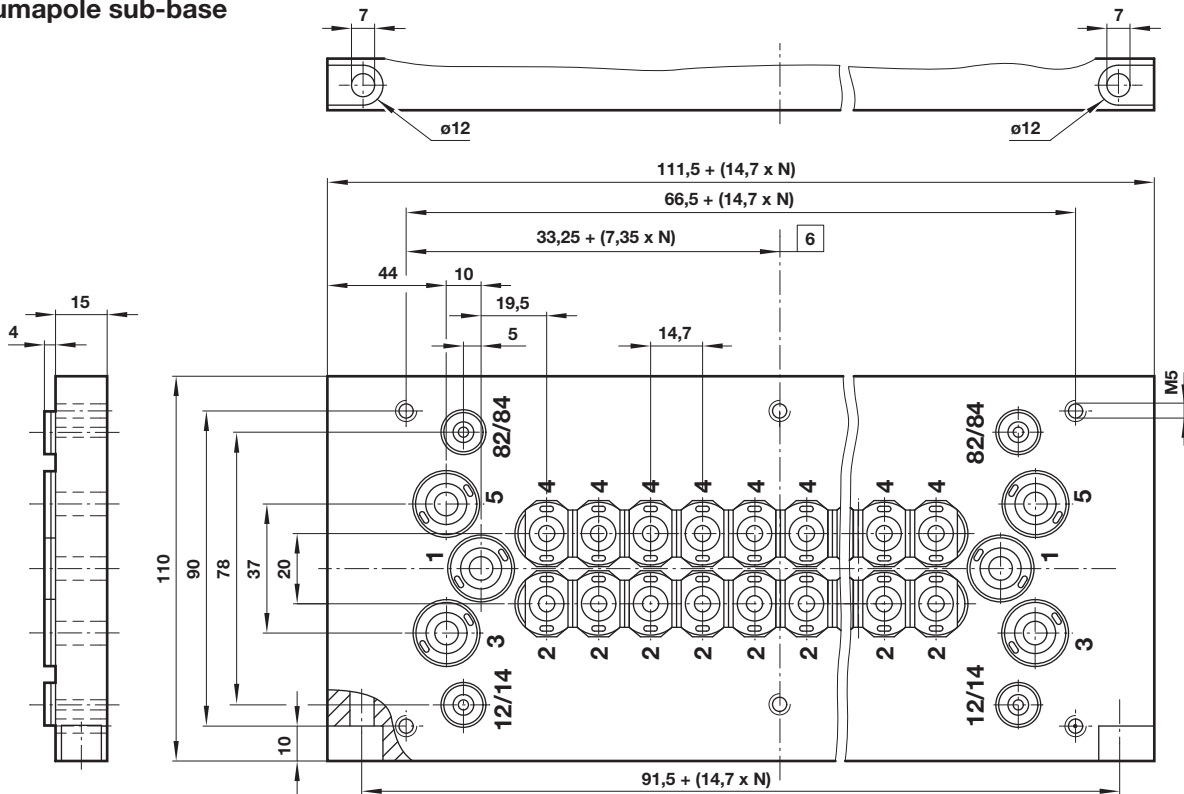

6 12 & 16 station only  
N = number of stations

Description	Ports 1, 3 & 5	Ports 12/14 & 82/84	Ports 2 & 4	Model
4 station Pneumapole	12	6	10	VM156517AQY604
6 station Pneumapole	12	6	10	VM156517AQY606
8 station Pneumapole	12	6	10	VM156517AQY608
10 station Pneumapole	12	6	10	VM156517AQY610
12 station Pneumapole	12	6	10	VM156517AQY612
16 station Pneumapole	12	6	10	VM156517AQY616

Note: Ports 82/84 (solenoid pilot exhausts) should not be plugged. A filter or silencer can be fitted or the air can be piped away with tubing.

**Multi-pressure options**

Dimensions in mm  
Projection/First angle

**Single pressure**

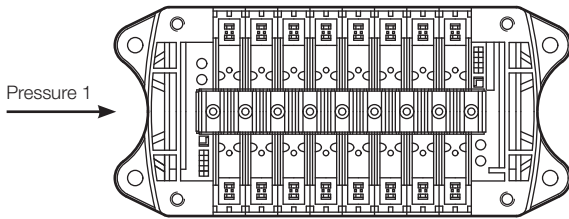

**Two pressure**

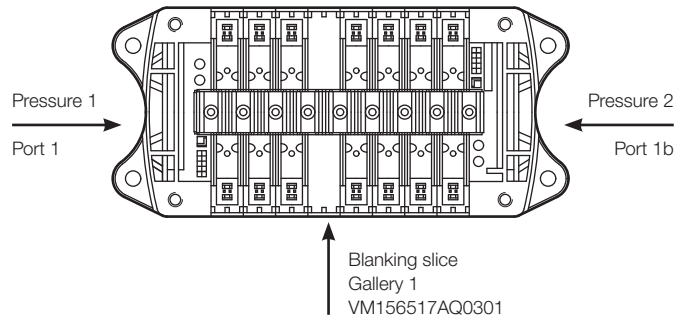

**Three pressure**

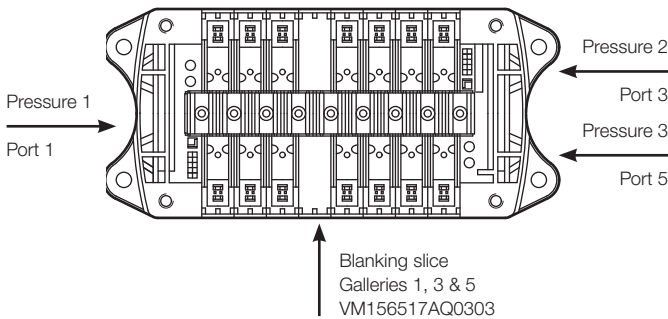

**Four pressure**

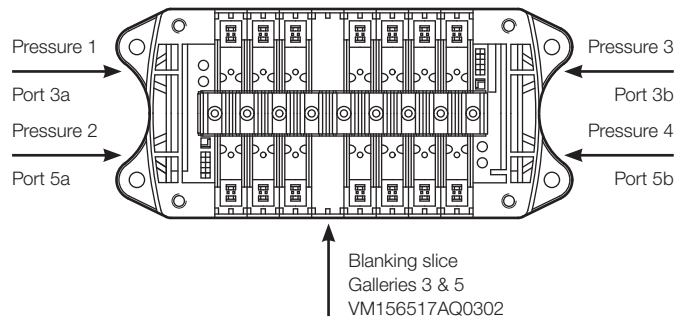

Please Note - the 3 & 4 Pressure islands shown above are achieved by using externally piloted 2x3/2 valves and reverse porting via ports 3 & 5, Please note that when 2x3/2 valves are reverse ported the functions are also reversed i.e. N/C becomes N/O and N/O becomes N/C

**Multi-pressure options – Intermediate Supply Exhaust Manifolds Single pressure**

**Feed right**

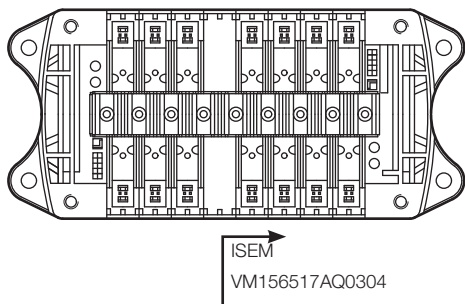

**Feed left**

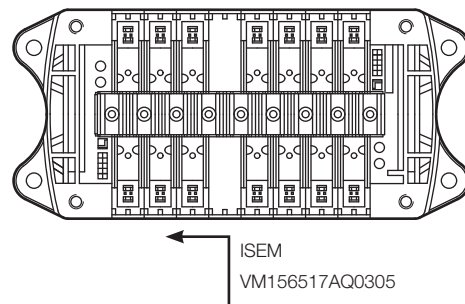

**Feed left and feed right**

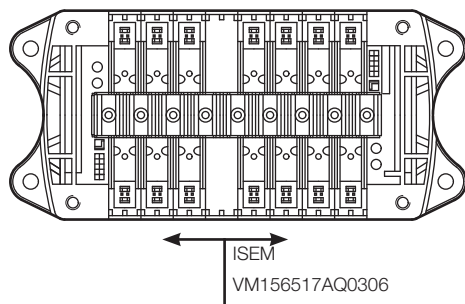

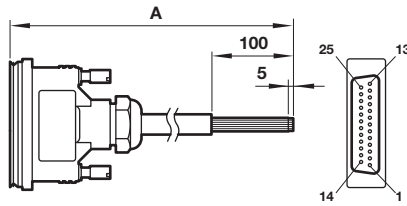

**D sub-connector 25 pin  
(IP65)**

A	Model
1 m	V11569-E01
3 m	V11569-E03
5 m	V11569-E05

Pin no.	Wire colour	Socket	Pilot	Station
1	White	Solenoid 1-a	14	1
2	Brown	Solenoid 2-a	14	2
3	Green	Solenoid 3-a	14	3
4	Yellow	Solenoid 4-a	14	4
5	Grey	Solenoid 5-a	14	5
6	Pink	Solenoid 6-a	14	6
7	Blue	Solenoid 7-a	14	7
8	Red	Solenoid 8-a	14	8
9	Black	Solenoid 9-a	14	9
10	Violet	Solenoid 10-a	14	10
11	Grey/Pink	Solenoid 11-a	14	11
12	Red/Blue	Solenoid 12-a	14	12
13	White/Green	Common-Ve		-
14	Brown/Green	Solenoid 1-b	12	1
15	White/Yellow	Solenoid 2-b	12	2
16	Yellow/Brown	Solenoid 3-b	12	3
17	White/Grey	Solenoid 4-b	12	4
18	Grey/Brown	Solenoid 5-b	12	5
19	White/Pink	Solenoid 6-b	12	6
20	Pink/Brown	Solenoid 7-b	12	7
21	White/Blue	Solenoid 8-b	12	8
22	Brown/Blue	Solenoid 9-b	12	9
23	White/Red	Solenoid 10-b	12	10
24	Brown/Red	Solenoid 11-b	12	11
25	White/Black	Solenoid 12-b	12	12

Note: Conforms to DIN 47100

**D Sub-connector 44 pin  
(IP65)**

Dimensions in mm  
Projection/First angle

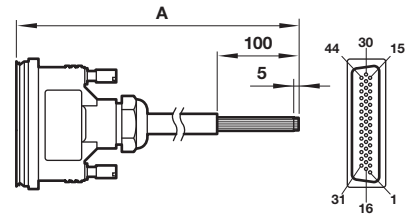

A	Model
1 m	V11570-E01
3 m	V11570-E03
5 m	V11570-E05

Pin no.	Wire colour	Socket	Pilot	Station
1	White	Solenoid 1-a	14	1
2	Brown	Solenoid 2-a	14	2
3	Green	Solenoid 3-a	14	3
4	Yellow	Solenoid 4-a	14	4
5	Grey	Solenoid 5-a	14	5
6	Pink	Solenoid 6-a	14	6
7	Blue	Solenoid 7-a	14	7
8	Red	Solenoid 8-a	14	8
9	Black	Solenoid 9-a	14	9
10	Violet	Solenoid 10-a	14	10
11	Grey/Pink	Solenoid 11-a	14	11
12	Red/Blue	Solenoid 12-a	14	12
13	White/Green	Solenoid 13-a	14	13
14	Brown/Green	Solenoid 14-a	14	14
15	White/Yellow	Solenoid 15-a	14	15
16	Yellow/Brown	Solenoid 1-b	12	1
17	White/Grey	Solenoid 2-b	12	2
18	Grey/Brown	Solenoid 3-b	12	3
19	White/Pink	Solenoid 4-b	12	4
20	Pink/Brown	Solenoid 5-b	12	5
21	White/Blue	Solenoid 6-b	12	6
22	Brown/Blue	Solenoid 7-b	12	7
23	White/Red	Solenoid 8-b	12	8
24	Brown/Red	Solenoid 9-b	12	9
25	White/Black	Solenoid 10-b	12	10
26	Brown/Black	Solenoid 11-b	12	11
27	Grey/Green	Solenoid 12-b	12	12
28	Yellow/Grey	Solenoid 13-b	12	13
29	Pink/Green	Solenoid 14-b	12	14
30	Yellow/Pink	Solenoid 15-b	12	15
31	Green/Blue	Solenoid 16-a	14	16
32	Yellow/Blue	Solenoid 16-b	12	16
33	—	Not used	—	—
34	—	Not used	—	—
35	—	Not used	—	—
36	—	Not used	—	—
37	—	Not used	—	—
38	—	Not used	—	—
39	—	Not used	—	—
40	—	Not used	—	—
41	—	Not used	—	—
42	—	Not used	—	—
43	—	Not used	—	—
44	Red/Black Yellow/Black	Common -Ve	—	—

**D Sub-connector 25 pin 90° (IP65)**

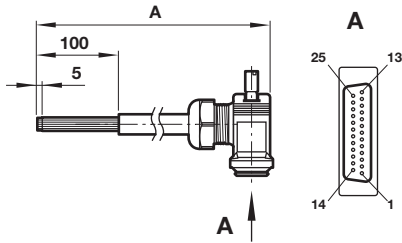

A	Model
1 m	V12086-E01
3 m	V12086-E03
5 m	V12086-E05

**D Sub-connector 44 pin 90° (IP65)**

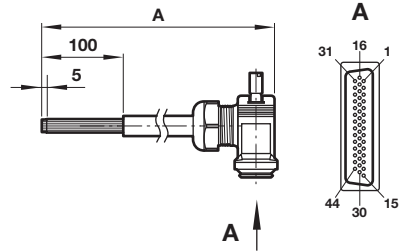

Dimensions in mm  
Projection/First angle



A	Model
1m	V12088-E01
3m	V12088-E03
5m	V12088-E05

Pin no.	Wire colour	Socket	Pilot	Station
1	White	Solenoid 1-a	14	1
2	Brown	Solenoid 2-a	14	2
3	Green	Solenoid 3-a	14	3
4	Yellow	Solenoid 4-a	14	4
5	Grey	Solenoid 5-a	14	5
6	Pink	Solenoid 6-a	14	6
7	Blue	Solenoid 7-a	14	7
8	Red	Solenoid 8-a	14	8
9	Black	Solenoid 9-a	14	9
10	Violet	Solenoid 10-a	14	10
11	Grey/Pink	Solenoid 11-a	14	11
12	Red/Blue	Solenoid 12-a	14	12
13	White/Green	Common-Ve	-	-
14	Brown/Green	Solenoid 1-b	12	1
15	White/Yellow	Solenoid 2-b	12	2
16	Yellow/Brown	Solenoid 3-b	12	3
17	White/Grey	Solenoid 4-b	12	4
18	Grey/Brown	Solenoid 5-b	12	5
19	White/Pink	Solenoid 6-b	12	6
20	Pink/Brown	Solenoid 7-b	12	7
21	White/Blue	Solenoid 8-b	12	8
22	Brown/Blue	Solenoid 9-b	12	9
23	White/Red	Solenoid 10-b	12	10
24	Brown/Red	Solenoid 11-b	12	11
25	White/Black	Solenoid 12-b	12	12

Note: Conforms to DIN 47100e

Pin no.	Wire colour	Socket	Pilot	Station
1	White	Solenoid 1-a	14	1
2	Brown	Solenoid 2-a	14	2
3	Green	Solenoid 3-a	14	3
4	Yellow	Solenoid 4-a	14	4
5	Grey	Solenoid 5-a	14	5
6	Pink	Solenoid 6-a	14	6
7	Blue	Solenoid 7-a	14	7
8	Red	Solenoid 8-a	14	8
9	Black	Solenoid 9-a	14	9
10	Violet	Solenoid 10-a	14	10
11	Grey/Pink	Solenoid 11-a	14	11
12	Red/Blue	Solenoid 12-a	14	12
13	White/Green	Solenoid 13-a	14	13
14	Brown/Green	Solenoid 14-a	14	14
15	White/Yellow	Solenoid 15-a	14	15
16	Yellow/Brown	Solenoid 1-b	12	1
17	White/Grey	Solenoid 2-b	12	2
18	Grey/Brown	Solenoid 3-b	12	3
19	White/Pink	Solenoid 4-b	12	4
20	Pink/Brown	Solenoid 5-b	12	5
21	White/Blue	Solenoid 6-b	12	6
22	Brown/Blue	Solenoid 7-b	12	7
23	White/Red	Solenoid 8-b	12	8
24	Brown/Red	Solenoid 9-b	12	9
25	White/Black	Solenoid 10-b	12	10
26	Brown/Black	Solenoid 11-b	12	11
27	Grey/Green	Solenoid 12-b	12	12
28	Yellow/Grey	Solenoid 13-b	12	13
29	Pink/Green	Solenoid 14-b	12	14
30	Yellow/Pink	Solenoid 15-b	12	15
31	Green/Blue	Solenoid 16-a	14	16
32	Yellow/Blue	Solenoid 16-b	12	16
33	-	Not used	-	-
34	-	Not used	-	-
35	-	Not used	-	-
36	-	Not used	-	-
37	-	Not used	-	-
38	-	Not used	-	-
39	-	Not used	-	-
40	-	Not used	-	-
41	-	Not used	-	-
42	-	Not used	-	-
43	-	Not used	-	-
44	Red/Black Yellow/Black	Common -Ve	-	-

**Pressure switch for  
pilot ports 12 & 14**

 Dimensions in mm  
Projection/First angle

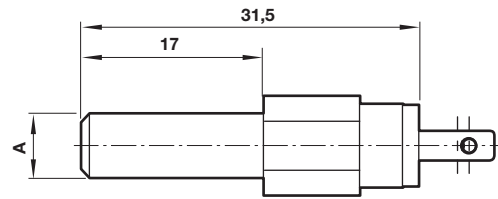

<b>Voltage:</b>	<b>24 V d.c.</b>
Pressure range:	0 ... 10 bar
Switching point rising pressure:	3 ... 5 bar
Switch point falling pressure:	2,5 ... 3,7 bar
AMP E-terminals:	2,8 x 0,8
Degree of protection:	IP00
Adjustment:	None

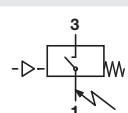

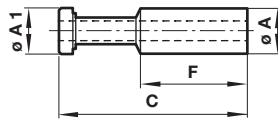
Symbol	A	Short code	Weight (kg)	Model
	6	7B	0,004	VM106517AQ0806

**Plug  
C0004**

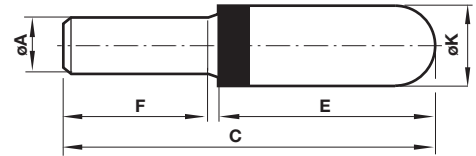
Ø A	Ø A1	C	F	Model
6	6	34	18,5	C00040600
8	8	38	21	C00040800
10	10	42	24	C00041000
12	12	46	29,5	C00041200

**Silencer**

Ø A	C	E	F	Ø K	Model
6	45	24,5	17	12,5	T45P0006
8	43,5	22	19	13,5	T45P0008
10	57,5	31	23	15,5	T45P0010
12	82	53	25	18,5	T45P0012

### Short codes for valve island specifications

Description	Manual override	Short code	Model
2 x 3/2 - 2 x NC - Internal feed valve 6 mm PIF	Turn & lock	NA6T	VM156A11AB213B
2 x 3/2 - 2 x NC - Internal feed valve 6 mm PIF	Push only	NA6U	VM156A11AB313B
2 x 3/2 - 2 x NC - Internal feed valve 8 mm PIF	Turn & lock	NA8T	VM158A11AB213B
2 x 3/2 - 2 x NC - Internal feed valve 8 mm PIF	Push only	NA8U	VM158A11AB313B
2 x 3/2 - 2 x NC - Internal feed valve 10 mm PIF	Turn & lock	NA1T	VM15YA11AB213B
2 x 3/2 - 2 x NC - Internal feed valve 10 mm PIF	Push only	NA1U	VM15YA11AB313B
2 x 3/2 - 2 x NC - Internal feed valve Pneumapole	Turn & lock	NAZT	VM157A11AB213B
2 x 3/2 - 2 x NC - Internal feed valve Pneumapole	Push only	NAZU	VM157A11AB313B
2 x 3/2 - 2 x NC - External feed valve 6 mm PIF	Turn & lock	ND6T	VM156A22AB213B
2 x 3/2 - 2 x NC - External feed valve 6 mm PIF	Push only	ND6U	VM156A22AB313B
2 x 3/2 - 2 x NC - External feed valve 8 mm PIF	Turn & lock	ND8T	VM158A22AB213B
2 x 3/2 - 2 x NC - External feed valve 8 mm PIF	Push only	ND8U	VM158A22AB313B
2 x 3/2 - 2 x NC - External feed valve 10 mm PIF	Turn & lock	ND1T	VM15YA22AB213B
2 x 3/2 - 2 x NC - External feed valve 10 mm PIF	Push only	ND1U	VM15YA22AB313B
2 x 3/2 - 2 x NC - External feed valve Pneumapole	Turn & lock	NDZT	VM157A22AB213B
2 x 3/2 - 2 x NC - External feed valve Pneumapole	Push only	NDZU	VM157A22AB313B
2 x 3/2 - 2 x NO - Internal feed valve 6 mm PIF	Turn & lock	NB6T	VM156B11AB213B
2 x 3/2 - 2 x NO - Internal feed valve 6 mm PIF	Push only	NB6U	VM156B11AB313B
2 x 3/2 - 2 x NO - Internal feed valve 8 mm PIF	Turn & lock	NB8T	VM158B11AB213B
2 x 3/2 - 2 x NO - Internal feed valve 8 mm PIF	Push only	NB8U	VM158B11AB313B
2 x 3/2 - 2 x NO - Internal feed valve 10 mm PIF	Turn & lock	NB1T	VM15YB11AB213B
2 x 3/2 - 2 x NO - Internal feed valve 10 mm PIF	Push only	NB1U	VM15YB11AB313B
2 x 3/2 - 2 x NO - Internal feed valve Pneumapole	Turn & lock	NBZT	VM157B11AB213B
2 x 3/2 - 2 x NO - Internal feed valve Pneumapole	Push only	NBZU	VM157B11AB313B
2 x 3/2 - 2 x NO - External feed valve 6 mm PIF	Turn & lock	NE6T	VM156B22AB213B
2 x 3/2 - 2 x NO - External feed valve 6 mm PIF	Push only	NE6U	VM156B22AB313B
2 x 3/2 - 2 x NO - External feed valve 8 mm PIF	Turn & lock	NE8T	VM158B22AB213B
2 x 3/2 - 2 x NO - External feed valve 8 mm PIF	Push only	NE8U	VM158B22AB313B
2 x 3/2 - 2 x NO - External feed valve 10 mm PIF	Turn & lock	NE1T	VM15YB22AB213B
2 x 3/2 - 2 x NO - External feed valve 10 mm PIF	Push only	NE1U	VM15YB22AB313B
2 x 3/2 - 2 x NO - External feed valve Pneumapole	Turn & lock	NEZT	VM157B22AB213B
2 x 3/2 - 2 x NO - External feed valve Pneumapole	Push only	NEZU	VM157B22AB313B

**Short codes for valve island specifications**

Description	Manual override	Short code	Model
2 x 3/2 - 1 x NC + 1 x NO - Internal feed valve 6 mm PIF	Turn & lock	NC6T	VM156C11AB213B
2 x 3/2 - 1 x NC + 1 x NO - Internal feed valve 6 mm PIF	Push only	NC6U	VM156C11AB313B
2 x 3/2 - 1 x NC + 1 x NO - Internal feed valve 8 mm PIF	Turn & lock	NC8T	VM158C11AB213B
2 x 3/2 - 1 x NC + 1 x NO - Internal feed valve 8 mm PIF	Push only	NC8U	VM158C11AB313B
2 x 3/2 - 1 x NC + 1 x NO - Internal feed valve 10 mm PIF	Turn & lock	NC1T	VM15YC11AB213B
2 x 3/2 - 1 x NC + 1 x NO - Internal feed valve 10 mm PIF	Push only	NC1U	VM15YC11AB313B
2 x 3/2 - 1 x NC + 1 x NO - Internal feed valve Pneumapole	Turn & lock	NCZT	VM157C11AB213B
2 x 3/2 - 1 x NC + 1 x NO - Internal feed valve Pneumapole	Push only	NCZU	VM157C11AB313B
2 x 3/2 - 1 x NC + 1 x NO - External feed valve 6 mm PIF	Turn & lock	NF6T	VM156C22AB213B
2 x 3/2 - 1 x NC + 1 x NO - External feed valve 6 mm PIF	Push only	NF6U	VM156C22AB313B
2 x 3/2 - 1 x NC + 1 x NO - External feed valve 8 mm PIF	Turn & lock	NF8T	VM158C22AB213B
2 x 3/2 - 1 x NC + 1 x NO - External feed valve 8 mm PIF	Push only	NF8U	VM158C22AB313B
2 x 3/2 - 1 x NC + 1 x NO - External feed valve 10 mm PIF	Turn & lock	NF1T	VM15YC22AB213B
2 x 3/2 - 1 x NC + 1 x NO - External feed valve 10 mm PIF	Push only	NF1U	VM15YC22AB313B
2 x 3/2 - 1 x NC + 1 x NO - External feed valve Pneumapole	Turn & lock	NFZT	VM157C22AB213B
2 x 3/2 - 1 x NC + 1 x NO - External feed valve Pneumapole	Push only	NFZU	VM157C22AB313B
5/2 Solenoid Spring - Internal feed valve 6 mm PIF	Turn & lock	NG6T	VM156517AB213B
5/2 Solenoid Spring - Internal feed valve 6 mm PIF	Push only	NG6U	VM156517AB313B
5/2 Solenoid Spring - Internal feed valve 8 mm PIF	Turn & lock	NG8T	VM158517AB213B
5/2 Solenoid Spring - Internal feed valve 8 mm PIF	Push only	NG8U	VM158517AB313B
5/2 Solenoid Spring - Internal feed valve 10 mm PIF	Turn & lock	NG1T	VM15Y517AB213B
5/2 Solenoid Spring - Internal feed valve 10 mm PIF	Push only	NG1U	VM15Y517AB313B
5/2 Solenoid Spring - Internal feed valve Pneumapole	Turn & lock	NGZT	VM157517AB213B
5/2 Solenoid Spring - Internal feed valve Pneumapole	Push only	NGZU	VM157517AB313B
5/2 Solenoid Spring - External feed valve 6 mm PIF	Turn & lock	NH6T	VM156527AB213B
5/2 Solenoid Spring - External feed valve 6 mm PIF	Push only	NH6U	VM156527AB313B
5/2 Solenoid Spring - External feed valve 8 mm PIF	Turn & lock	NH8T	VM158527AB213B
5/2 Solenoid Spring - External feed valve 8 mm PIF	Push only	NH8U	VM158527AB313B
5/2 Solenoid Spring - External feed valve 10 mm PIF	Turn & lock	NH1T	VM15Y527AB213B
5/2 Solenoid Spring - External feed valve 10 mm PIF	Push only	NH1U	VM15Y527AB313B
5/2 Solenoid Spring - External feed valve Pneumapole	Turn & lock	NHZT	VM157527AB213B
5/2 Solenoid Spring - External feed valve Pneumapole	Push only	NHZU	VM157527AB313B

### Short codes for valve island specifications

Description	Manual override	Short code	Model
5/2 Solenoid Solenoid - Internal feed valve 6 mm PIF	Turn & lock	NJ6T	VM156511AB213B
5/2 Solenoid Solenoid - Internal feed valve 6 mm PIF	Push only	NJ6U	VM156511AB313B
5/2 Solenoid Solenoid - Internal feed valve 8 mm PIF	Turn & lock	NJ8T	VM158511AB213B
5/2 Solenoid Solenoid - Internal feed valve 8 mm PIF	Push only	NJ8U	VM158511AB313B
5/2 Solenoid Solenoid - Internal feed valve 10 mm PIF	Turn & lock	NJ1T	VM15Y511AB213B
5/2 Solenoid Solenoid - Internal feed valve 10 mm PIF	Push only	NJ1U	VM15Y511AB313B
5/2 Solenoid Solenoid - Internal feed valve Pneumapole	Turn & lock	NJZT	VM157511AB213B
5/2 Solenoid Solenoid - Internal feed valve Pneumapole	Push only	NJZU	VM157511AB313B
5/2 Solenoid Solenoid - External feed valve 6 mm PIF	Turn & lock	NK6T	VM156522AB213B
5/2 Solenoid Solenoid - External feed valve 6 mm PIF	Push only	NK6U	VM156522AB313B
5/2 Solenoid Solenoid - External feed valve 8 mm PIF	Turn & lock	NK8T	VM158522AB213B
5/2 Solenoid Solenoid - External feed valve 8 mm PIF	Push only	NK8U	VM158522AB313B
5/2 Solenoid Solenoid - External feed valve 10 mm PIF	Turn & lock	NK1T	VM15Y522AB213B
5/2 Solenoid Solenoid - External feed valve 10 mm PIF	Push only	NK1U	VM15Y522AB313B
5/2 Solenoid Solenoid - External feed valve Pneumapole	Turn & lock	NKZT	VM157522AB213B
5/2 Solenoid Solenoid - External feed valve Pneumapole	Push only	NKZU	VM157522AB313B
5/3 APB Solenoid Solenoid - Internal feed valve 6 mm PIF	Turn & lock	NL6T	VM156611AB213B
5/3 APB Solenoid Solenoid - Internal feed valve 6 mm PIF	Push only	NL6U	VM156611AB313B
5/3 APB Solenoid Solenoid - Internal feed valve 8 mm PIF	Turn & lock	NL8T	VM158611AB213B
5/3 APB Solenoid Solenoid - Internal feed valve 8 mm PIF	Push only	NL8U	VM158611AB313B
5/3 APB Solenoid Solenoid - Internal feed valve 10 mm PIF	Turn & lock	NL1T	VM15Y611AB213B
5/3 APB Solenoid Solenoid - Internal feed valve 10 mm PIF	Push only	NL1U	VM15Y611AB313B
5/3 APB Solenoid Solenoid - Internal feed valve Pneumapole	Turn & lock	NLZT	VM157611AB213B
5/3 APB Solenoid Solenoid - Internal feed valve Pneumapole	Push only	NLZU	VM157611AB313B
5/3 APB Solenoid Solenoid - External feed valve 6 mm PIF	Turn & lock	NM6T	VM156622AB213B
5/3 APB Solenoid Solenoid - External feed valve 6 mm PIF	Push only	NM6U	VM156622AB313B
5/3 APB Solenoid Solenoid - External feed valve 8 mm PIF	Turn & lock	NM8T	VM158622AB213B
5/3 APB Solenoid Solenoid - External feed valve 8 mm PIF	Push only	NM8U	VM158622AB313B
5/3 APB Solenoid Solenoid - External feed valve 10 mm PIF	Turn & lock	NM1T	VM15Y622AB213B
5/3 APB Solenoid Solenoid - External feed valve 10 mm PIF	Push only	NM1U	VM15Y622AB313B
5/3 APB Solenoid Solenoid - External feed valve Pneumapole	Turn & lock	NMZT	VM157622AB213B
5/3 APB Solenoid Solenoid - External feed valve Pneumapole	Push only	NMZU	VM157622AB313B

## Short codes for valve island specifications

Description		Short code	Model
End plate kit - feed both ends	12 mm	F200	VM156517AQ010Z
End plate kit - feed both ends	10 mm	F100	VM156517AQ010Y
End plate kit - right blocked	12 mm	L200	VM156517AQ011Z
End plate kit - right blocked	10 mm	L100	VM156517AQ011Y
End plate kit - left blocked	12 mm	R200	VM156517AQ012Z
End plate kit - left blocked	10 mm	R100	VM156517AQ012Y
End plate kit - feed both ends - Pneumapole	no PIF	FPZ0	VM156517AQ0134
End plate kit - left blocked - Pneumapole	no PIF	RPZ0	VM156517AQ0136
End plate kit - right blocked - Pneumapole	no PIF	LPZ0	VM156517AQ0135
Blank body	B000		VM156517AQ0300
Port 1 blanked	B100		VM156517AQ0301
Ports 3 & 5 blanked	B300		VM156517AQ0302
Ports 1, 3 & 5 blanked	B500		VM156517AQ0303
ISEM Feed right	RM80		VM156517AQ0304
ISEM Feed left	LM80		VM156517AQ0305
ISEM Feed right & left	FM80		VM156517AQ0306
4 station Pneumapole	Standard	1B04	VM156517AQY604
6 station Pneumapole	Standard	1B06	VM156517AQY606
8 station Pneumapole	Standard	1B08	VM156517AQY608
10 station Pneumapole	Standard	1B10	VM156517AQY610
12 station Pneumapole	Standard	1B12	VM156517AQY612
16 station Pneumapole	Standard	1B16	VM156517AQY616

## Warning

These products are intended for use in industrial compressed air systems only. Do not use these products where pressures and temperatures can exceed those listed under

### »Technical features/data«.

Before using these products with fluids other than those specified, for non-industrial applications, life-support systems or other applications not within published specifications, consult IMI NORGREN.

Through misuse, age, or malfunction, components used in fluid power systems can fail in various modes.

The system designer is warned to consider the failure modes of all component parts used in fluid power systems and to provide adequate safeguards to prevent personal injury or damage to equipment in the event of such failure.

System designers must provide a warning to end users in the system instructional manual if protection against a failure mode cannot be adequately provided.

System designers and end users are cautioned to review specific warnings found in instruction sheets packed and shipped with these products.